

ELEV-8 Flight Controller (#80204)

The ELEV-8 Flight Controller is a single-board quadcopter control solution, designed to control the Parallax ELEV-8 v3 quadcopter (#80300).

The ELEV-8 Flight Controller features the Propeller P8X32A, a 32-bit, 8-core microcontroller. Its multicore architecture allows simultaneous sensor monitoring and motor control, without interrupts. The ELEV-8 Flight Controller hardware, its C-language firmware, and the accompanying Ground Station software for configuration, diagnostics, and live telemetry, are all open source.

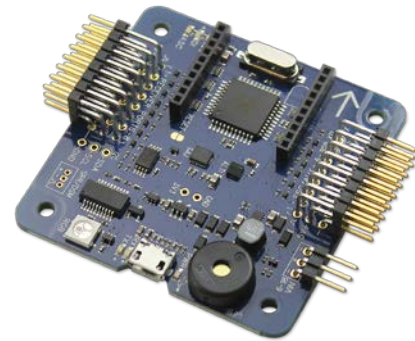

This product guide has been updated for the release of the ELEV-8 Flight Controller Rev B. For details, see Revision History at the end of the document.

Note: This document only covers the Flight Controller Hardware, for information on the Firmware, look under the Downloads and Documentation section of the #80204 product page.

Features

- 32-bit, 8-core, 80 MHz Propeller P8X32A microcontroller with 64 KB EEPROM
- Wide supply voltage range compatible with 2S to 5S battery packs
- Center-positive 3-pin power-in header to avoid reverse polarity connection
- Micro-USB socket for configuration, testing and custom software development
- Automatically selects between USB and external power sources
- USB over-current protection when power supplied by USB
- LSM9DS1 IMU (3D accelerometer, 3D gyroscope, 3D magnetometer)
- LPS25H pressure sensor for altimeter and barometer data
- RF module socket for wireless telemetry; XBee 900 MHz modules recommended
- Battery voltage monitor with low-battery alarm
- Piezospeaker for status alerts and alarms
- Onboard WS2812B addressable RGB LED for status and flight mode indication
- RGB LED expansion header for connecting up to 20 additional WS2812B RGB LEDs
- Serial Tx/Rx duplex expansion port
- Eight bi-directional receiver ports
- Six bi-directional ESC/AUX ports for Parallax xRotor 20A ESCs
- All 14 bi-directional ports are re-assignable, to allow up to 14 ESCs and motors
- All headers are standard 0.1" spaced 3-pin headers
- Unpopulated I2C bus header for custom applications
- Convenient reset touch-button pad for firmware development
- 6 Indicator LEDs show the status of USB power/Tx/Rx, and RF ASC/Tx/Rx
- 3.3 V linear and 5 V switching voltage regulators

- Unpopulated 3.3V & GND (2pin header) near center of PCB
- Unpopulated SRR/DSM header for compatibility with Spektrum receivers

Key Specifications

- Power requirements: 6-18 VDC
- Typical operating current (without optional accessories): 100 mA
- Maximum total current supply to external 5 V devices: 1.5 Amp
- Maximum source current per I/O signal port: 6 mA
- Maximum input voltage per I/O signal port: 5.25 V
- Piezospeaker sound pressure: 60–80 dBA at 10 cm
- Main control loop duration, original firmware release: 250 Hz (4 ms)
- Sensor read loop duration, original firmware release: 500 Hz (2 ms)
- ESC PWM output frequency: 400 Hz (2.5 ms)
- Communication: USB micro-B (onboard serial over USB converter)
- Compatible external RGB module: WS2812B recommended
- Compatible RF Module: XBee
- PCB Dimensions: 2.165 x 2.165 inches (55 x 55 mm)
- Operating temp range: +32 to +158 °F (0 to +70 °C)
- Corner mounting holes: 3 mm, at 45 mm spacing
- Weight: ~ 19 grams (0.67 oz.)

Online Resources

For instructions on using the ELEV-8 Flight Controller with the ELEV-8 v3 Quadcopter, see the tutorials at learn.parallax.com/elev-8.

Install FTDI USB drivers for your operating system before connecting the ELEV-8 Flight Controller to your computer: <http://www.ftdichip.com/Drivers/VCP.htm>

Official releases of the ELEV-8 Flight Controller hardware, firmware, and Ground Station software are posted on www.parallax.com and linked to the #80204 product page. Note that it is important to use the recommended version of the Ground Station Software with each version of the Flight Controller Firmware.

Interim releases and the open-source firmware/software project itself are available from the Parallax GitHub site. <https://github.com/parallaxinc/Flight-Controller>.

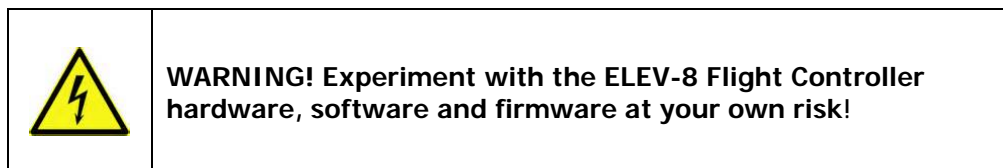

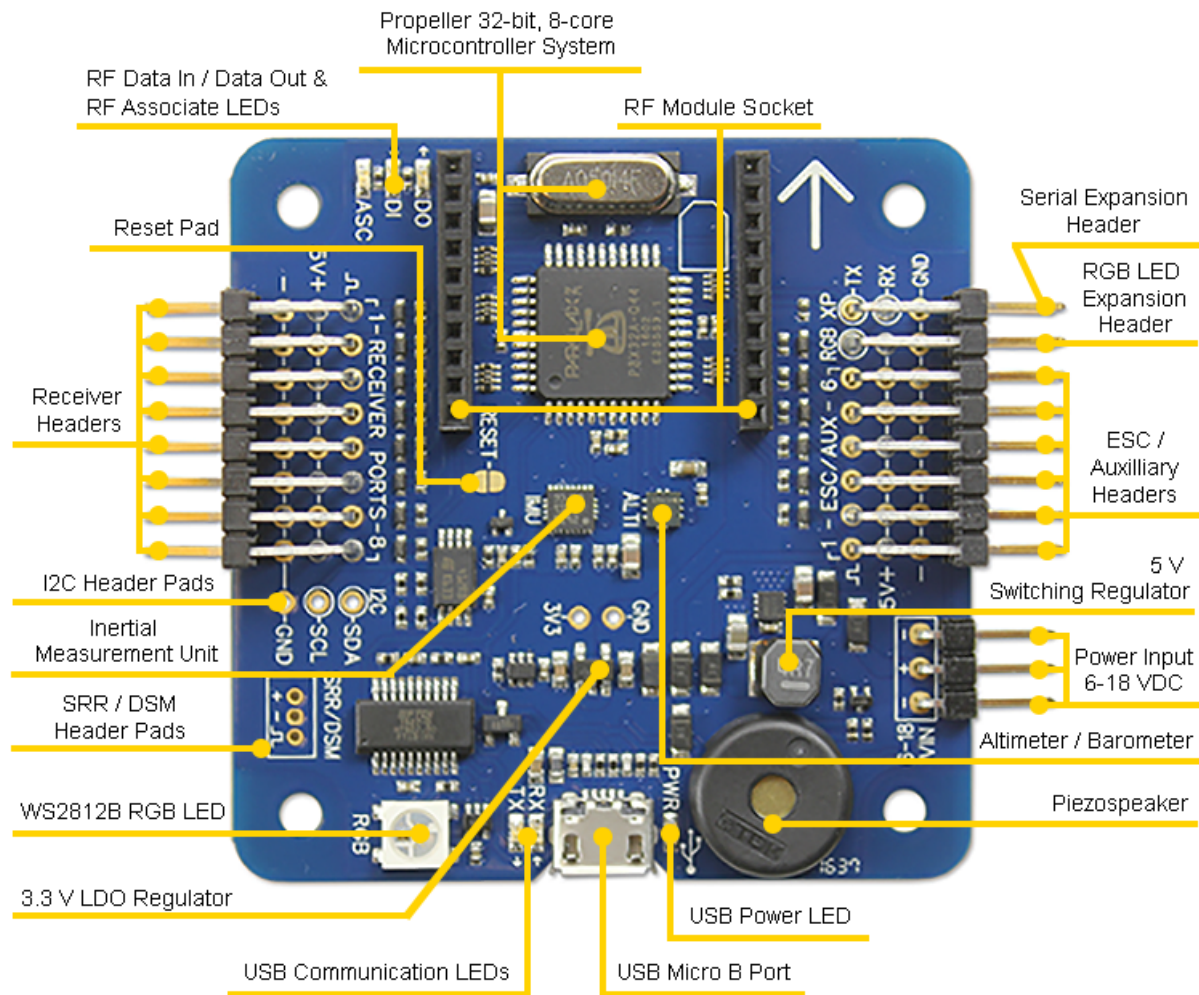

Functional Description

Multicore Propeller Microcontroller System

- 64 KB I2C EEPROM for non-volatile program and data storage.
- 32-bit, 8-core Propeller P8X32A microcontroller
- 3.3 V, 500 mA voltage regulator
- 5.00 MHz crystal oscillator

The Propeller P8X32A uses I/O pins P28 and P29 to communicate with the 64 KB I2C EEPROM for program and data storage. The lower 32 KB contains the program that the Propeller loads on reset. The upper 32 KB can be used for non-volatile data storage. The crystal oscillator connected to the Propeller provides a clock signal for the system. The Propeller can multiply its 5 MHz oscillator signal by up to 16 for a system clock frequency of 80 MHz.

See the Propeller I/O Pin Assignments on page 9 for additional details.

RF Module Socket

This socket simplifies the use of an RF module to provide a means of communication with the pilot on the ground. It has 2 mm pin spacing and is compatible with XBee modules. A pair of XBee-PRO 900HP SB3 DigiMesh Modules (XBP9B-DMST-002) (#32411) and Digi 900 MHz RPSMA Antenna, Female (A09-HASM-675) are recommended. The XBee USB Adapter (#32400) may be used to connect one XBee module to a computer running the Ground Station software, to provide live sensor telemetry data. See the tutorial “ELEV-8 v3 Wireless Telemetry via XBee” at <http://learn.parallax.com/elev-8> for directions on properly configuring and connecting the XBee modules.

| | |
|---|--|
|  | WARNING! Do NOT attempt to use 2.4 GHz RF modules with the ELEV-8 Flight Controller, including XBee 802.15.4 or XBee-PRO ZB series modules! This can cause interference on the 2.4 GHz range used by 2.4 GHz transmitters and receivers, resulting in unpredictable motor behavior. |
|---|--|

RF Indicator LEDs

There are 3 LEDs associated with the RF Module Socket. The ASC LED will blink when an installed RF module connects to a remote module and is ready to exchange data. The DO and DI LEDs will blink rapidly as data is being transmitted or received with the remote module.

Serial Expansion Header

The Serial Expansion Header (marked XP) has 0.1" pin spacing, oriented vertically. It provides a duplex serial port for customer expansion.

The RX pin has a 10 k-ohm pull-down resistor installed on the Flight Controller. The TX pin has no pull-down resistor; the customer's external hardware is expected to include one. This arrangement means that the Flight Controller can be programmed to detect the presence of an external device by checking the state of the TX pin at startup.

RGB LED Expansion Header

RGB LED Expansion Header (marked RGB) has 0.1" pin spacing, oriented vertically. The pinout for the RGB header is the same as the neighboring ESC headers: GND nearest the outside edge of the PCB, +5V at the middle pin, and SIGNAL on the remaining (inside) pin.

This header will support up to 20 additional WS2812B RGB LEDs. These can be used to add additional lighting effects to your quadcopter. Some simple firmware editing may be required to set the number of external RGB modules.

| | |
|---|--|
|  | WARNING! Do NOT connect more than 20 external RGB LED modules to the Flight Controller 5 V supply! Do NOT exceed the 5 V supply's 1.5 A limit; carefully calculate peak current draw of all devices when adding accessories to your Flight Controller! If you wish to add more than the recommended maximum number of RGB LED modules, you must NOT source power for them from the Flight Controller. |
|---|--|

ESC / Auxiliary Headers

The ESC and AUX headers have 0.1" pin spacing, oriented vertically. There are 6 ports, each with 5 V power, GND, and bi-directional communication (see the Propeller I/O Pin Assignments on page 9). These are typically connected to a standard ESC (Electronic Speed Controller) such as the Parallax xRotor 20A ESC (#750-90015) included in the ELEV-8 v3 Quadcopter Kit.

The ESC ports could also be used to drive standard servos (such as a camera gimbal), provided that the total current requirements of the servo motor are considered, and these external loads do not exceed the maximum available on the Flight Controller (maximum 1.5 A total).

When configured for input, each I/O port is 5 V tolerant—equipped with a 10 k-ohm series resistor and Schottky diode—and will typically sense high when the input voltage reaches 1.65 V. In output mode, each I/O port can provide (source) up to 6 mA of current, and will typically be 3.3 V when high, and 0 V when low.

The Parallax xRotor 20A ESC (#750-90015) is a non-BEC type (Non-Battery Eliminator Circuit), meaning it does not contain a voltage regulator to provide 5 V power supply to the Flight Controller. This is fine, because the Parallax Flight Controller has its own onboard 5 V power regulator.

The ESC and AUX ports signal (IO) pins are open. The Flight Controller does not have pullup or pulldown resistors at these pins, so the user application is completely flexible to configure these pins as required.

The ESC and AUX headers can be re-assigned by editing the open-source Flight Controller firmware, should you wish to interface with a gimbal, camera or proximity detector.

Piezospeaker

The piezospeaker is used to provide audible feedback of important events, such as arming, disarming and low-battery conditions. Note that when the Flight Controller is powered only via a USB connection, the piezospeaker may not be audible.

| | |
|---|--|
|  | WARNING! The sound output from the piezospeaker is 60–80 dBA at 10 cm. Take appropriate precautions (such as using headphones or ear plugs) when using the Flight Controller in close proximity, such as during development or setup. |
|---|--|

Power Input

The Power Input header, marked VIN, has 0.1" pin spacing, oriented horizontally. The board can be powered from a voltage in the 6–18 VDC range. This voltage range is compatible with standard battery packs comprised of 2, 3, 4, or 5 cells, and is compatible with lithium polymer batteries available from Parallax (3300 mAh, #752-00010 and 5300 mAh, #752-00017).

The polarity is marked on the board; the center pin is positive, and the two outer pins are negative (GND). Only one of the negative terminals needs to be connected, which provides flexibility with the choice of power supply cable.

| | |
|---|--|
|  | WARNING! ALWAYS double-check your connections and ensure your battery is connected with the correct polarity BEFORE plugging into your Flight Controller! |
|---|--|

Altimeter / Barometer

The LPS25H sensor contains an ultra-compact absolute piezo-resistive pressure sensor. It provides absolute barometer readings in the 260-1260 hPa range, which the Flight Controller uses to determine altitude. The sensor has a tiny air hole in the top of its case that must be protected from water ingress, direct sunlight, and direct airflow to ensure accurate readings; a piece of open-cell foam serves this purpose in the ELEV-8 v3 Quadcopter Kit.

USB Micro-B Socket

The USB socket can be used to load the Flight Controller firmware, to provide power to the Flight Controller during testing, and to communicate with the Parallax Ground Station software.

The Flight Controller USB interface uses a standard FTDI USB controller. For best results, download and install FTDI drivers for your operating system before connecting the Flight Controller to your computer; they are available from <http://www.ftdichip.com/Drivers/VCP.htm>. which most computers will automatically recognize and install when connecting for the first time. If you need to download drivers, please check the resources section at the end of this document, or contact Parallax Technical Support for assistance.

The USB 2.0 specification limits individual USB devices from drawing more than 500 mA from a computer. As such the Flight Controller USB port is input current limited to prevent it exceeding 500 mA.

The typical current consumption of the Flight Controller without optional accessories will not exceed 100 mA. Powering optional accessories, such as an XBee wireless module, additional RGB LEDs, or other external devices through the Flight Controller will increase the current requirements. When customizing your Flight Controller application, calculate the total current draw of external devices, and disable or unplug them when working from USB power as needed.

| | |
|---|--|
|  | WARNING! It is NOT recommended to connect the Flight Controller to a Non-Powered USB hub, as that may not be able to supply the full 500 mA per port. |
|---|--|

USB Indicator LEDs

There are 3 LEDs associated with the USB circuitry. PWR will light when a valid USB power source is connected, TX and RX will blink as data is being transmitted or received.

Switching 5 V Regulator

The switching regulator is a high efficiency buck type, able to deliver up to 1.8 A at 5 V. The regulator converts the high VIN battery voltage down to 5 V, to provide power to the 3.3 V linear regulator, the RGB LED module, and all of the external 5 V ports.

The regulator operates at 1.5 MHz, and has short-circuit protection, overcurrent limiting, and automatic shutdown in case of overheating. The Flight Controller requires up to 300 mA from the switching regulator, leaving 1.5 A for external devices.

| | |
|---|--|
|  | WARNING! Do NOT overload the switching regulator! Ensure that the total peak current requirement of the Flight Controller AND any external devices does not exceed 1.8 A! |
|---|--|

Linear 3.3 V Regulator

The linear 3.3 V LDO regulator provides power to the Propeller microcontroller, EEPROM, sensors, and optionally an RF module when installed. It is also used to set the logic level voltage at the I/O ports.

Inertial Measurement Unit

The LSM9DS1 is an inertial measurement unit containing a 3D digital linear acceleration sensor, a 3D digital angular rate sensor, and a 3D digital magnetometer.

The IMU allows the Propeller microcontroller to interpret the actual movement of the quadcopter, which enables assisted flight features such as self-leveling and automatic stabilization. The Flight Controller software reads the values from all these sensors and updates an internal estimate of its orientation. This estimate is compared against the desired orientation, taken from pilot commands, and used to adjust the motor output, hundreds of times per second.

RGB LED module

The onboard WS2812B RGB LED module is used to display status information about your Flight Controller. Different colors indicate specific states and flight modes. Please refer to the firmware guide for details about the colors and meanings.

I2C Header Pads

The I2C header pads have 0.1" pin spacing, and provide advanced developers access to the Propeller I2C bus. Please refer to the Flight Controller schematic for information required to make use of this feature; it is available for download from the #80204 product page at www.parallax.com.

Receiver Headers

The receiver headers have 0.1" pin spacing oriented vertically. They provide 8 ports, each with 5 V power, GND, and bi-directional communication with a Propeller I/O pin; see the Propeller I/O Pin Assignments on page 9. These are typically connected to the channels on a standard RC receiver, such as the Spektrum AR610 6-Channel Receiver (#80206) or the Spektrum AR8000 8-Channel DSMX Receiver which is included with Spektrum's DX7 Transmitter kit (#730-80300).

When configured for input, each I/O port is 5 V tolerant, and will typically sense high when the input voltage reaches 1.65 V. In output mode, each I/O port can provide (source) up to 6mA of current, and will typically be 3.3 V when high, and 0 V when low.

The receiver ports could also be re-purposed as additional ESC/AUX ports by modifying the open-source Flight Controller firmware. The Receiver port signal pins are open; the Flight Controller does not have pullup or pulldown resistors at these pins, so the user application is completely flexible to configure these pins as required.

Reset Pad

This feature is only intended for use during advanced firmware development. Shorting together the reset pads with a metal object, such as tweezers or a small screwdriver tip, will cause the Propeller to immediately reload the code stored in EEPROM and re-start. If required, a push-to-make reset switch could also be soldered to the exposed reset pads provided the cables were kept short (up to 5 cm).

SRR/DSM Header Pads

The SRR/DSM header pads are compatible with Spektrum brand remote receivers. The 3 pads are on 0.059" (1.50mm) pitch, and will accept a JST ZH series connector, such as part number: S3B-ZR(LF)(SN). The pins definitions are as follows:

| Pin | Cable Color (Typical) | Purpose |
|-----|-----------------------|---------------------------------|
| 1 | Orange | 3.3VDC +/-5%, 20mA max |
| 2 | Black | GND |
| 3 | Gray | DATA (Connected to RCV port #1) |

Pin 3 is the data pin, and is connected directly to the 1st receiver port. As such, **do not use both RCV port #1 and the SRR/DSM receiver at the same time.**

The DSM type of receiver allows all of the receiver channels to be processed through the single RCV port #1. This simplifies cabling and means that the other RCV ports (2-8) are free for customer custom applications.

Accessory Power Header Pads

The accessory power header pads are provided as a convenience for custom applications only. Power is provided from the onboard 3.3V LDO regulator which also powers the rest of the Flight Controller and optional XBee module. Accordingly, it is not recommended to exceed 100mA load from the accessory power header pads, to ensure enough power is available for the rest of the Flight Controller. The 3.3V and GND pads will accept standard 0.1" spaced 2-pin headers.



WARNING! It is the user responsibility to ensure that use of the accessory power does NOT overload the Flight Controller, as that can make it unsafe for flight.

Propeller I/O Pin Assignments

| I/O Pin | Default Firmware Alias | Function |
|---------|------------------------|---|
| P0 | PIN_RC_4 | Receiver port 5 |
| P1 | PIN_RC_5 | Receiver port 6 |
| P2 | PIN_RC_6 | Receiver port 7 |
| P3 | PIN_RC_7 | Receiver port 8 |
| P4 | PIN_LED | RGB LED |
| P5 | PIN_CS_M | SPI CS (Magnetometer, active low chip select) |
| P6 | PIN_CS_AG | SPI CS (Accelerometer & gyro, active low chip select) |
| P7 | PIN_SDO | SPI SDO (Data Out) |
| P8 | PIN_SDI | SPI SDI (Data In) |
| P9 | PIN_SCL | SPI SCL (Clock) |
| P10 | PIN_CS_ALT | SPI CS (Altimeter, active low chip select) |
| P11 | PIN_BUZZER_1 | Piezo buzzer |
| P12 | PIN_MOTOR_FL | ESC port 1 (Motor Front-Left) |
| P13 | PIN_MOTOR_FR | ESC port 2 (Motor Front-Right) |
| P14 | PIN_MOTOR_BR | ESC port 3 (Motor Back-Right) |
| P15 | PIN_MOTOR_BL | ESC port 4 (Motor Back-Left) |
| P16 | PIN_VBATT | Battery monitor (RCTIME) |
| P17 | PIN_MOTOR_AUX1 | ESC port 5 (Aux 1) |
| P18 | PIN_MOTOR_AUX2 | ESC port 6 (Aux 2) |
| P19 | PIN_XP_RX | Serial Expansion Bus (XP) RX |
| P20 | PIN_XP_TX | Serial Expansion Bus (XP) TX |
| P21 | PIN_XBEE_RX | RF module RX (Data In) |
| P22 | PIN_XBEE_TX | RF module TX (Data Out) |
| P23 | PIN_XBEE_ASSOC | RF module ASC (High when module associated) |
| P24 | PIN_RC_2 | Receiver port 3 |

| | | |
|-----|-------------|---|
| P25 | PIN_RC_0 | Receiver port 1 -OR- SRR/DSM data pin |
| P26 | PIN_RC_1 | Receiver port 2 |
| P27 | PIN_RC_3 | Receiver port 4 |
| P28 | PIN_I2C_CLK | EEPROM / I2C clock |
| P29 | PIN_I2C_DAT | EEPROM / I2C data |
| P30 | - | TX (USB programming / terminal) |
| P31 | - | RX (USB programming / terminal) |

Dimensions

(not to scale)

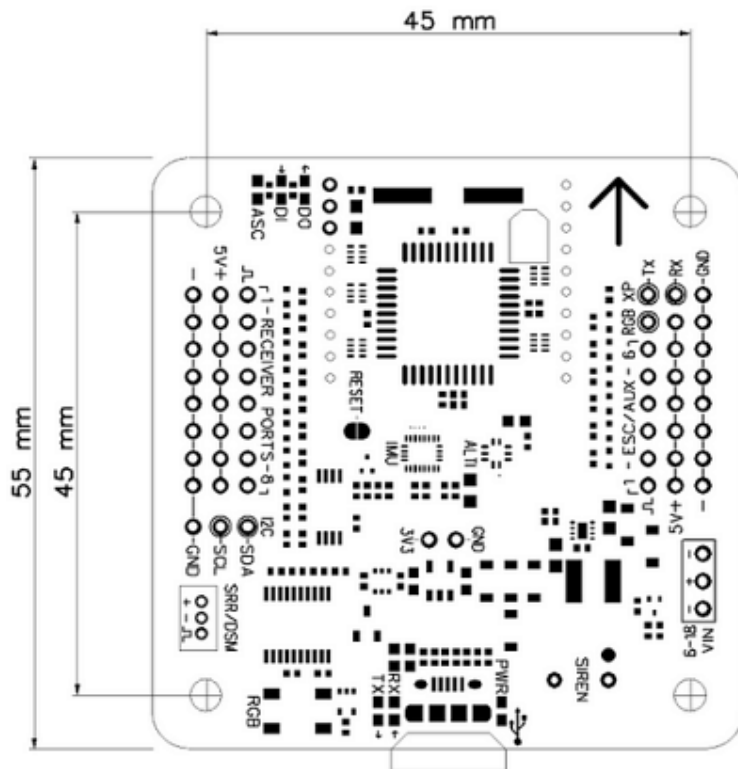

Revision History

Version 1.0: Original release

Version 1.1: Updated the introductory paragraph, page 1, the Piezospeaker section, page 5; and the RF Module Socket section, page 4.

Version 1.2: Updated for board version Rev B. New images, updated references to board labels that have changed, added sections for Accessory Power Header Pads, SRR/DSM Header Pads.